

# A novel method for coupling capillary columns in GC, GCxGC, CZE and all other coupled-column capillary separation techniques



Wil van Egmond<sup>1,2</sup>, Daniela Peroni<sup>2</sup>, Jaap de Zeeuw<sup>3</sup>, Jan Blomberg<sup>4</sup> and Hans-Gerd Janssen<sup>2,5</sup>

<sup>1</sup>-NLISIS, Veldhoven, The Netherlands, <sup>2</sup>-University of Amsterdam, <sup>3</sup>-Restek, Middelburg, <sup>4</sup>-Shell Global Solutions International, Amsterdam, <sup>5</sup>-Unilever R&D, Vlaardingen.

## Introduction

Modern separation systems frequently use coupled-column set-ups. This is the case in advanced applications as GCxGC, but also in more standard situations, such as a simple coupling of a pre-column or retention gap to the analytical column. Coupling capillary columns is difficult. The connections should be leak-tight, free of dead volume, inert, easy to make and replace, cheap, etc. Using a proprietary, low-melting, deactivated glass we have developed a novel instant Melfit™ connection. Reliable connectors are made in-situ in less than a minute.

## Instrumentation

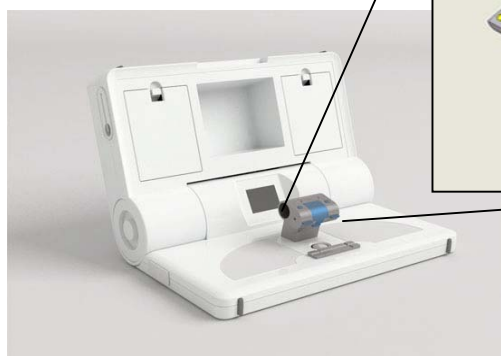

Nlisis Melfit One™.

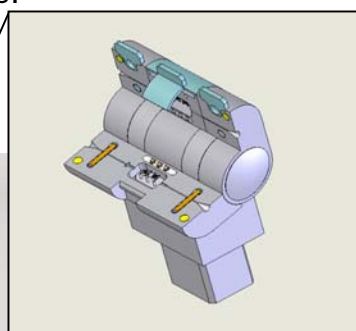

## Melfit™ connection

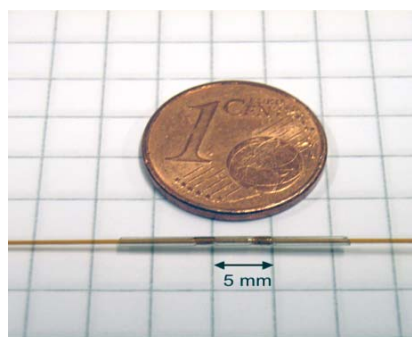

Instant Melfit™ GC columns, inner diameter 320 μm.

## Principle of the method

1. A glass tube with an inner diameter exactly matching the outer diameter of the (thickest) capillary is selected.
2. The glass tube is positioned in the Melfit One™ instrument.
3. The capillaries are inserted in the glass tube.
4. The melting procedure is started. It is fully computer controlled and involves three steps:
  - Local melting of the glass at the two welding positions
  - Shrinking at the weld position by applying gas pressure.
  - Controlled cooling.
5. Ready.

## Test protocol

Connections for GC and GCxGC were tested on the following aspects:

- Leak-tightness
  - elevated pressure (H<sub>2</sub> and He)
  - vacuum
- Dead-volume band broadening
- Inertness
  - adsorption (modified Grob test)
  - thermal degradation (Donike test)
- Selected applications in GC and GCxGC

## Results and Discussion

### 1. Leak-tightness

Leak-tight up to at least 20 bar. Performance with MS (vacuum) also excellent

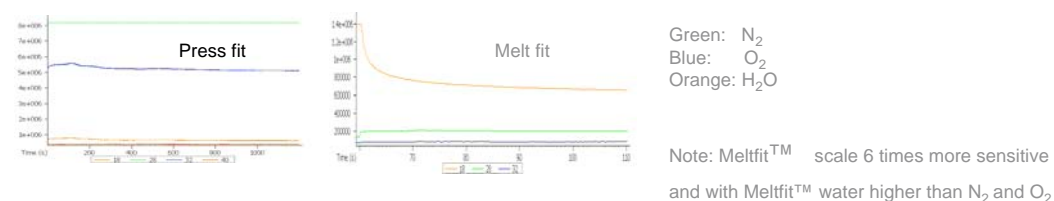

### 2. Dead volume and band broadening

GC column: Restek RTX-5, d<sub>c</sub> = 100 μm, L = 10 m, d<sub>f</sub> = 0.4 μm. Inlet pressure 3.5 bar. Test compound: methane at 45°C (isothermal).

Asymmetry factor (at 10% height) and band width (n = 5)

# connections	Asymmetry factor	Peak width (n=5)
1	1.04	0.01
3	1.03	0.01
5	1.02	0.01
11	1.00	0.01

### 3. Inertness: Grob test (adsorption)

Compound	Asymmetry factor		
	1	3	11
1,2-dichlorobenzene	1.00	1.00	1.00
1,4-dichlorobenzene	1.00	1.00	1.00
1,2-dibromobenzene	1.00	1.00	1.00
1,4-dibromobenzene	1.00	1.00	1.00

Asymmetry factor (at 10% height) (n=3)

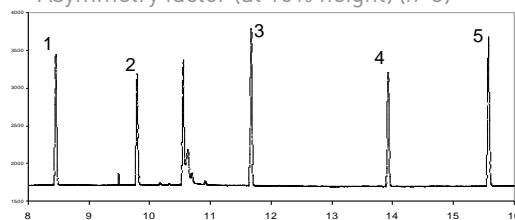

Chromatogram with 11 connections

### Donike test (thermal degradation)

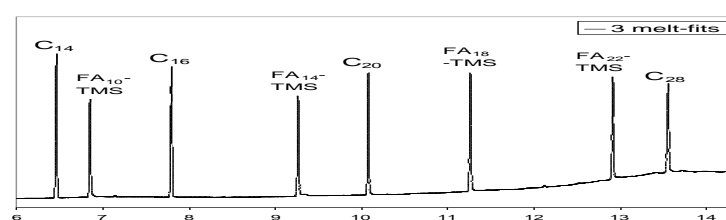
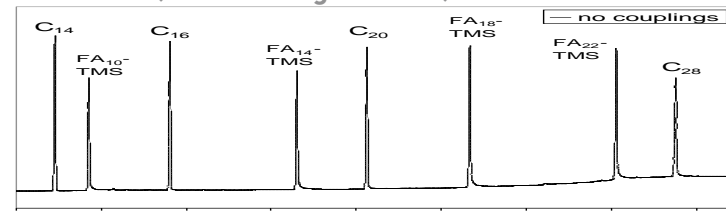

If there is no thermal degradation, the peaks of the trimethylsilyl esters of the fatty acids should show no changes. When degradation occurs they will decrease. The inactive alkanes are used as references for the height.

## Conclusions

Nlisis Melfit™ connections are easy to make and reliable.

Nlisis Melfits™ are leak tight, both under vacuum conditions as well as at the high inlet pressures encountered in fast GC (up to 20 bar).

Couplings are free of dead volume, even in case of 100 μm columns, and are highly inert.

The new column connectors are successfully used in GC and GCxGC applications.

Preliminary experiments demonstrate the applicability of the new connections for μLC and CZE.

## Contact details

NLISIS BV, De Sitterlaan 7,  
5505 AA Veldhoven,  
the Netherlands.  
Telephone: +31 40-3686066  
E-mail: [wil@nlisis.com](mailto:wil@nlisis.com)  
Website: [www.nlisis.com](http://www.nlisis.com)

## Collaborations

